

Bluetooth LED Driver

Especially for magnetic track & linear lamp

- Bluetooth 5.0 SIG Mesh with high networking capability is reliable and stable.
- Support direct control on iOS or Android devices through Bluetooth connection.
- Support online upgrade. With ultra-low power consumption, it can be continuously powered on and off to reset it to factory defaults.
- Setting the soft start time and lighting status is supported.
- Work with Super Panel to achieve voice control, cloud scenes and automation.
- No input polarity.
- Multiple output current settings.
- DC to DC constant current output.
- Suitable for STUCCHI standard housings.
- Magnetic installation is quiet without high-frequency sound.
- Smooth dimming curves without flicker.
- Short circuit, overload, no-load and anti-reverse protection.
- 5 year warranty.

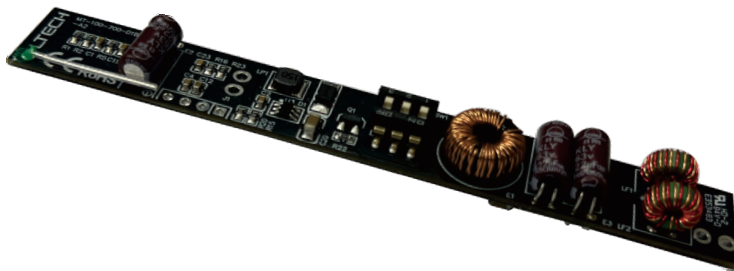

Flicker-free
IEEE 1789



RoHS

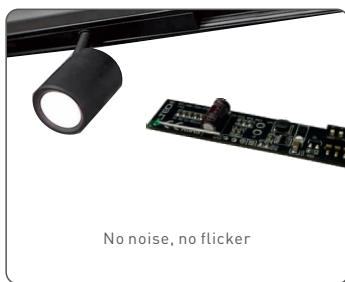

Technical Specs

MODEL		MT-100-400-D1B1	MT-350-700-D1B1
OUTPUT	Output Voltage	9-42Vdc	
	Output Current	100-400mA	350-700mA
	Output Power	1W-16.8W	
	Current Accuracy	+15mA/-25mA	±5%
	Dimming Range	0~100%, down to 1%	
	Channel	1	
INPUT	Dimming Interface	Bluetooth 5.0 SIG Mesh	
	Input Voltage	48Vdc±5% (No polarity)	
	Input Current	0.38A	0.65A
	Efficiency (Typ)	94%	
	Standby Power	<0.5W	
ENVIRONMENT	Working Temperature	ta: -20~55°C tc: 87°C	
	Storage Temperature	-40~80°C	
	Working Humidity	20~95%RH, non-condensing	
PROTECTION	Overload Protection	The load voltage is out of range and the current drops until the power is turned on again.	
	Short Circuit Protection	Close output and automatically recover once the fault is removed.	
	Input Anti -reverse Protection	No input polarity , able to output normally.	

Output Current Selection

* Please select the current through DIP switches on the circuit board when the power is off.



DIP Switch		↑ ↓ ↓	↓ ↑ ↓	↑ ↑ ↓	↓ ↓ ↑	↑ ↓ ↑	↓ ↑ ↑	↑ ↑ ↑	↑ ↓
MT-100-400-D1B1	Output Current	100mA	150mA	200mA	250mA	300mA	350mA	400mA	ON OFF
	Output Voltage	10-42V	10-42V	10-42V	10-42V	10-42V	10-42V	10-42V	
	Output Power	1-4.2W	1.5-6.3W	2-8.4W	2.5-10.5W	3-12.6W	3.5-14.7W	4-16.8W	

DIP Switch		↓ ↓ ↓	↑ ↓ ↓	↓ ↑ ↓	↑ ↑ ↓	↓ ↓ ↑	↑ ↓ ↑	↓ ↑ ↑	↑ ↑ ↑	↑ ↓
MT-350-700-D1B1	Output Current	350mA	400mA	450mA	500mA	550mA	600mA	650mA	700mA	ON OFF
	Output Voltage	10-42V	10-42V	10-42V	10-42V	10-42V	10-42V	10-42V	10-42V	
	Output Power	3.5-14.7W	4-16.8W	4.5-18.9W	5-21W	5.5-23.1W	6-25.2W	6.5-27.3W	7-29.4W	

Dimensions

Unit:mm

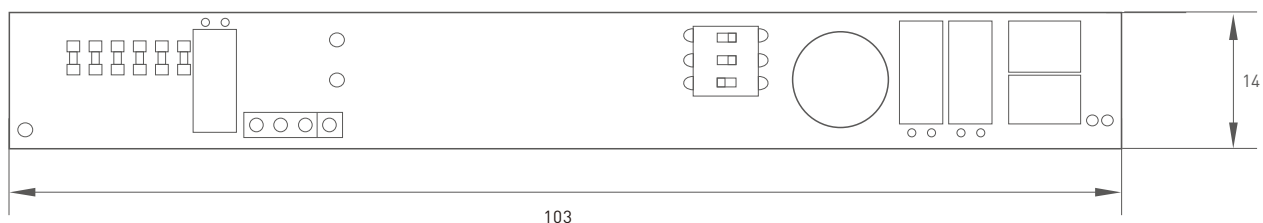

Terminal Description

PCB board

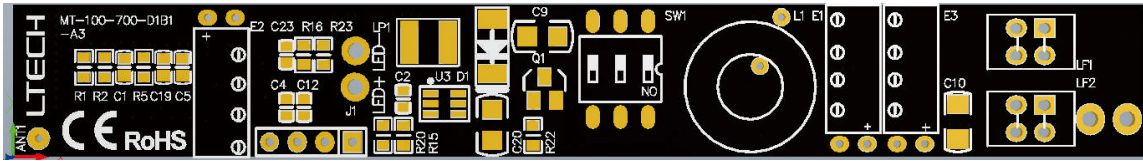

Main view

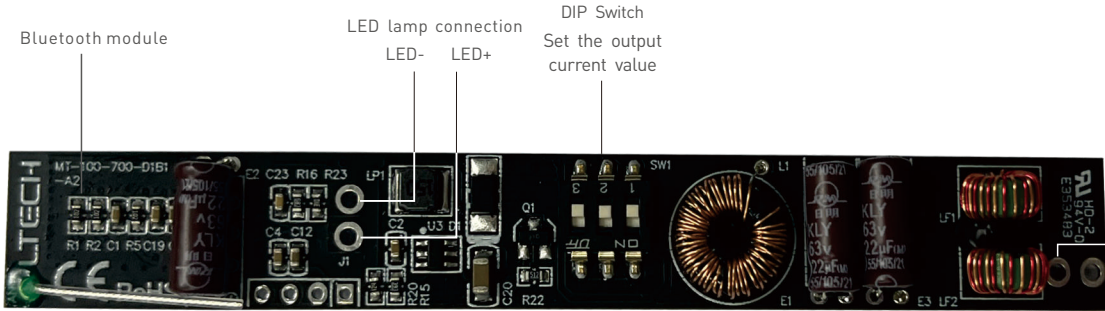

Side view

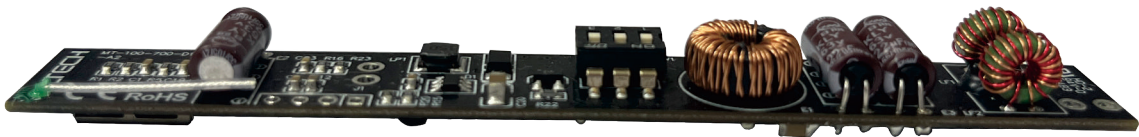

Input voltage
(No polarity)

Wiring Diagram

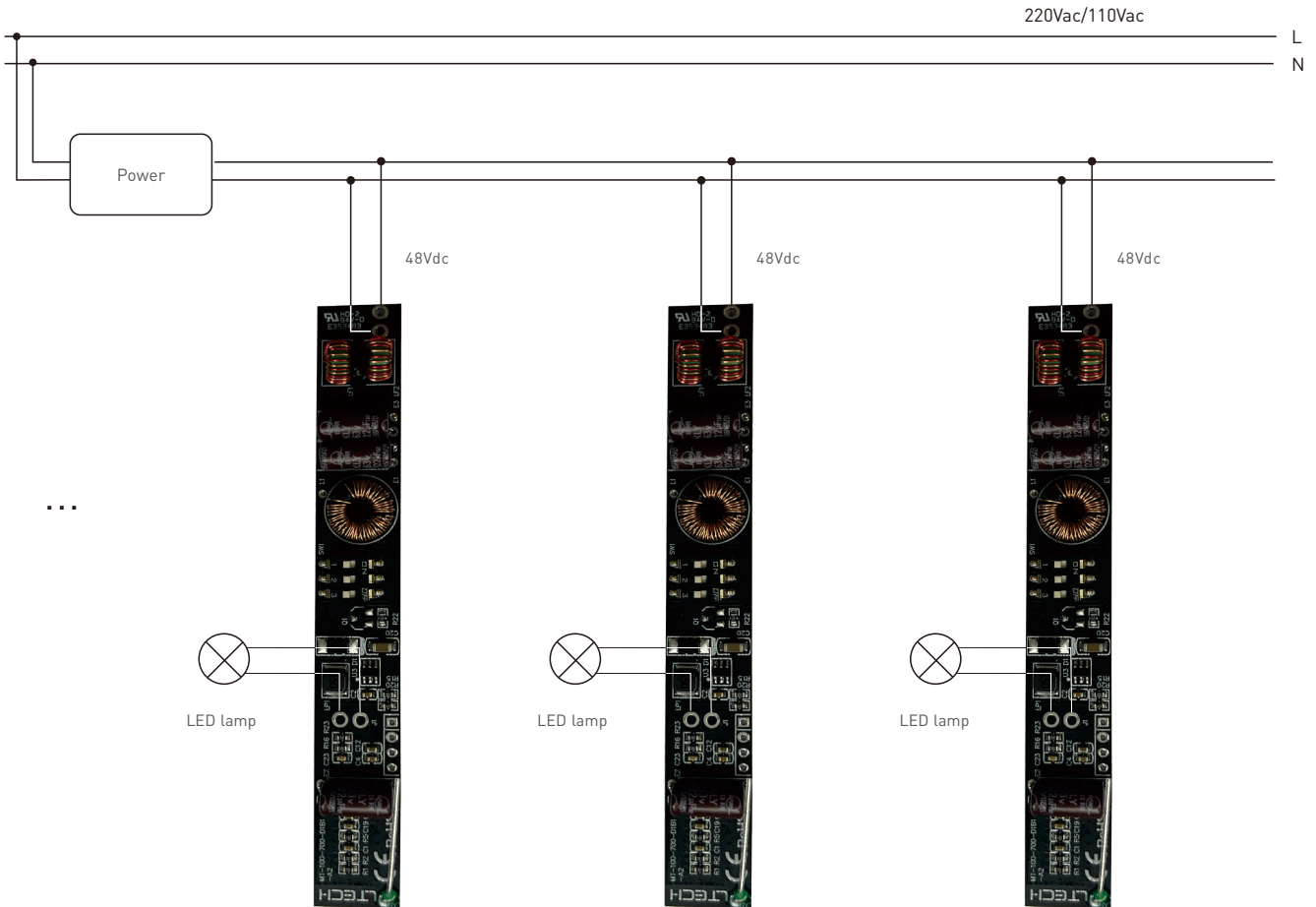

App Operating Instructions

1. Register an account

The App is available on iOS or Android devices. Scan the QR code below with you mobile phone and follow the prompts to complete the App installation. Open the App to log in or register an account.



Scan and download the App

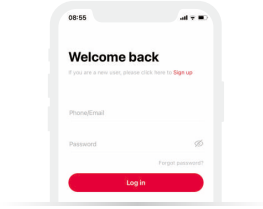

2. Control interface settings

Create a home if you are a new user. Click “+” icon in the upper right corner and access the “Add Device” list. Follow the prompts to add the driver first, then pick “Smart lighting” - “DIM light (BLE)” in the device list. Follow the prompts to power on the device first and make sure the device is not connected to the network, then click “Bluetooth Search” and follow the prompts to add the device.



3. Control interface settings

After pairing your device, go to the control interface. You'll be able to achieve your desired lighting effects by changing brightness. Click “Theme” and you'll easily switch to multiple theme lighting effects with one tap. Click “Mode” and the App provides you editable advanced modes. Customize dynamic modes to put you into a more colorful life.

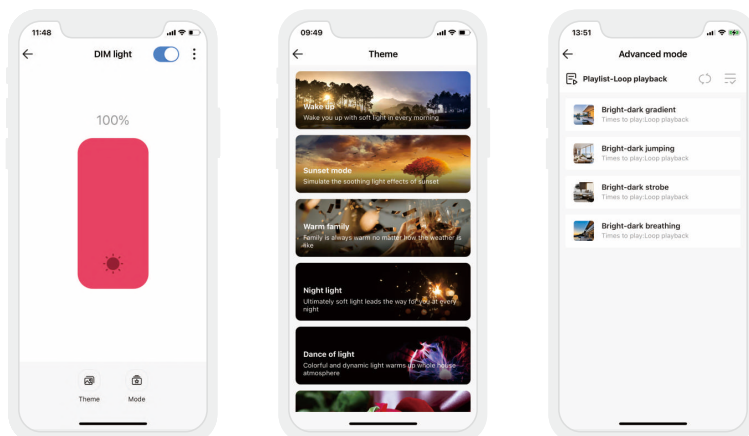

4. Light groups

Users are able to combine the same type of lights into a group. Once you create the group, you can control the entire group of lights more easily. In "Room" interface, click "+" icon in the upper right corner to access "Add Device" list, and select the light group you want, such as "DIM Light Group", then pick the lights you want to group together .

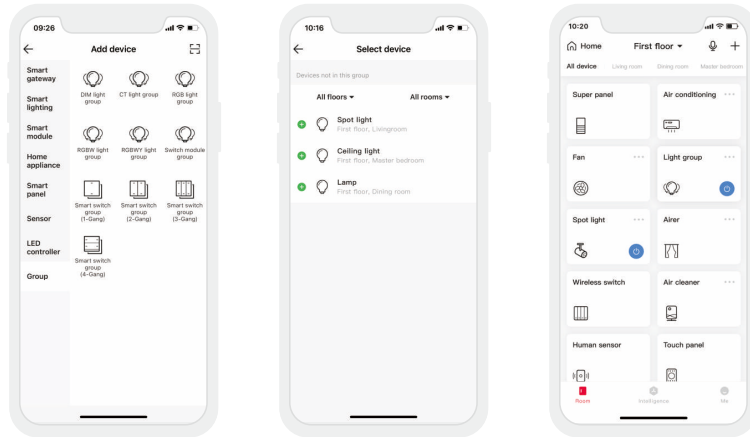

5. Advanced functions

The driver can be linked up with gateway function devices (such as LTECH Super Panel) to achieve the advanced functions such as cloud scenes and automation.

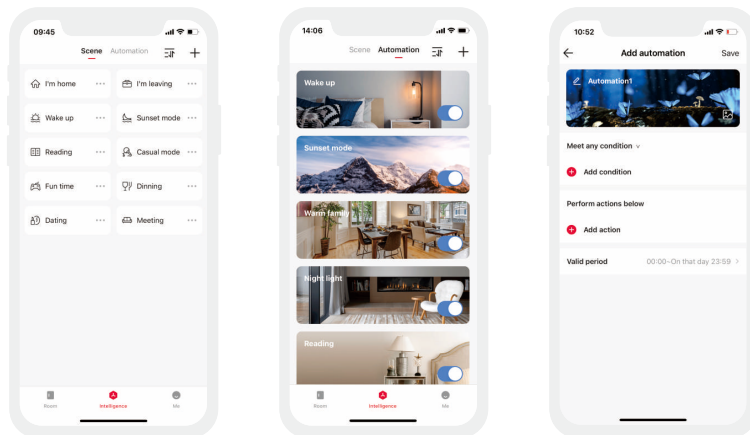

Reset The Device (Reset to factory defaults)

Make sure the driver is well-connected to a lamp and the lamp is on, turn it off with the switch and after 5s turn it on. After 2s, turn it off again. Repeat the same operation 6 times. When the indicator light flashes 5 times, reset the device to factory defaults successfully.

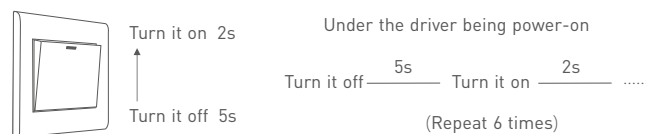

Packaging Specifications

Model	MT-100-400-D1B1、 MT-350-700-D1B1
Carton Dimensions	37×29×19mm (L×W×H)
Quantity	240 PCS/Carton
Weight	0.015 kg/PC; 4.4 kg/Carton

Packaging Image



Carton Packaging

Transportation and Storage

1. Transportation

Products can be shipped via vehicles, boats and planes. During transportation, products should be protected from rain and sun. Please avoid severe shock and vibration during the loading and unloading process.

2. Storage

The storage conditions should comply with the Class I Environment Standards. The products that have been stored for more than six months are recommended to be re-inspected and can be used only after they have been qualified.

FAQs

1. What should I do if I fail to add the device?
 - 1.1 Please make sure the device is powered on normally and is in the activated mode.
 - 1.2 Please make sure the device hasn't been added by any other account. If it did, please reset to factory defaults manually.
 - 1.3 The recommended distance between the mobile phone and the device is no more than 20 meters.
 - 1.4 If the device has been forced to delete, please reset to factory defaults manually and then add the device again.
2. What should I do if the device disconnects from the network?
 - 2.1 Please make sure the device is powered on normally.
 - 2.2 Please make sure the router works normally and the network runs smoothly.
 - 2.3 If you control the device remotely, please make sure your phone network runs smoothly.
3. How to control remotely and set cloud scenes?

Remote control and cloud scenes can be achieved only by working with LTECH Super Panel.
4. How to share control of your home devices?

Please go to "Me" - "Home Management" and access the home you want to share.

Click "Add Member" and follow the prompts to add members to your home.

Attentions

- This product must be installed and adjusted by a qualified professional.
 - This product is non-waterproof (special models excepted). Please avoid the sun and rain. When installed outdoors, please ensure it is mounted in a water proof enclosure.
 - Good heat dissipation will extend the life the product. Please install the product in a environment with good ventilation.
 - Please keep the product away from a intense magnetic field, a high pressure area or a place where lightning is easy to occur.
 - Please check whether the working voltage used complies with the parameter requirements of the product.
 - Before you power on the product, please make sure all the wiring is correct in case of incorrect connection that may cause a short circuit and damage the components, or trigger a accident.
 - If a fault occurs, please do not attempt to fix the product by yourself. If you have any question, please contact the supplier.
- * This manual is subject to changes without further notice. Product functions depend on the goods. Please feel free to contact our official distributors if you have any question.

Warranty Agreement

- Warranty periods from the date of delivery : 5 years.
- Free repair or replacement services for quality problems are provided within warranty periods.

Warranty exclusions below:

- Beyond warranty periods.
- Any artificial damage caused by high voltage, overload, or improper operations.
- Products with severe physical damage.
- Damage caused by natural disasters and force majeure.
- Warranty labels and barcodes have been damaged.
- No any contract signed by LTECH.

1. Repair or replacement provided is the only remedy for customers. LTECH is not liable for any incidental or consequential damage unless it is within the law.
2. LTECH has the right to amend or adjust the terms of this warranty, and release in written form shall prevail.

Update Log

Version	Updated Time	Update Content	Updated by
A0	2020.09.11	Original version.	Xu Shujun
A1	2022.01.21	Added "Output Voltage Range" to P1.	Xu Shujun
A2	2022.06.01	Added "tc: 87 °C" to P1.	Xu Shujun
A3	2022.08.30	Updated the parameter for all products: Updated "Efficiency (Typ)" value as "94%"	Yang Weiling
A4	2023.09.15	Update all product diagrams; PBC board, size, Wiring diagram.	Yang Weiling

蓝牙驱动器

磁吸灯/线条灯专用

- Bluetooth 5.0 SIG Mesh通信协议，组网能力强，可靠稳定；
- 支持IOS和安卓智能设备蓝牙直连控制；
- 支持在线升级功能，具有超低功耗功能，可连续断上电恢复出厂设置；
- 可设置缓启动渐变时间、通电后灯光状态等，赋予灯光设计高端品质；
- 可搭配超级面板实现语音控制、云场景、云自动化控制；
- 输入不分正负极；
- 多档输出电流设置；
- DC to DC恒流输出；
- 适用于STUCCHI标准外壳；
- 磁吸安装应用安静无高频干扰声；
- 调光曲线平滑、无闪烁；
- 短路，过载，空载、防反接保护；
- 5年质保。

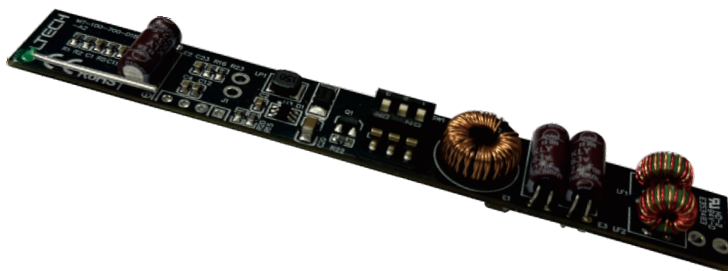

Flicker-free
IEEE 1789



RoHS



技术参数

型号		MT-100-400-D1B1	MT-350-700-D1B1
输出	输出电压	9~42Vdc	
	工作电流范围	100~400mA	350~700mA
	负载功率范围	1W~16.8W	3.5W~29.4W
	电流精度	+15mA/-25mA	±5%
	调光范围	0~100%，调光深度 1%	
	通道	1	
输入	调光接口	Bluetooth 5.0 SIG Mesh	
	输入电压	48Vdc±5% (输入不分正负)	
	输入电流	0.38A	0.65A
	效率 (Typ)	94%	
	待机功耗	<0.5W	
环境	工作温度	ta: -20~55°C tc: 87°C	
	储存温度	-40~80°C	
	工作湿度	20~95%RH, 无冷凝	
保护	过载保护	负载电压超范围，电流下降，故障移除自动恢复	
	短路保护	输出关闭，故障移除自恢复	
	输入防反接保护	输入不分正负，都可正常输出	

输出电流选择

注：请在断电情况下，通过在电路板上的DIP开关选择电流。



DIP开关		↑ ↓ ↓	↓ ↑ ↓	↑ ↑ ↓	↓ ↓ ↑	↑ ↓ ↑	↓ ↑ ↑	↑ ↑ ↑	↑ ↓ ON OFF
MT-100-400-D1B1	电流输出	100mA	150mA	200mA	250mA	300mA	350mA	400mA	
	电压输出	10-42V	10-42V	10-42V	10-42V	10-42V	10-42V	10-42V	
	功率输出	1-4.2W	1.5-6.3W	2-8.4W	2.5-10.5W	3-12.6W	3.5-14.7W	4-16.8W	

DIP开关		↓ ↓ ↓	↑ ↓ ↓	↓ ↑ ↓	↑ ↑ ↓	↓ ↓ ↑	↑ ↓ ↑	↓ ↑ ↑	↑ ↑ ↑	↑ ↓ ON OFF
MT-350-700-D1B1	电流输出	350mA	400mA	450mA	500mA	550mA	600mA	650mA	700mA	
	电压输出	10-42V	10-42V	10-42V	10-42V	10-42V	10-42V	10-42V	10-42V	
	功率输出	3.5-14.7W	4-16.8W	4.5-18.9W	5-21W	5.5-23.1W	6-25.2W	6.5-27.3W	7-29.4W	

产品尺寸

单位：mm

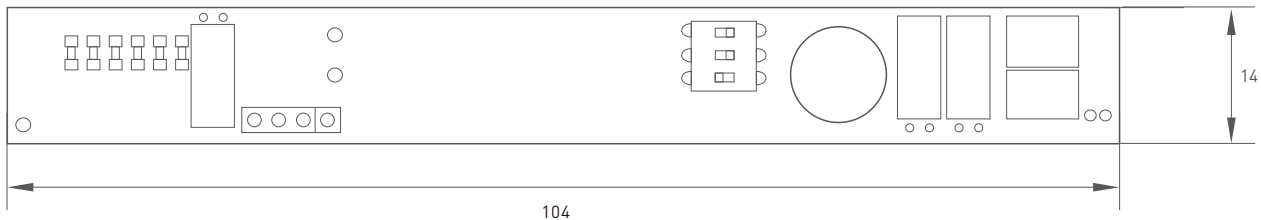

端子描述

PCB板

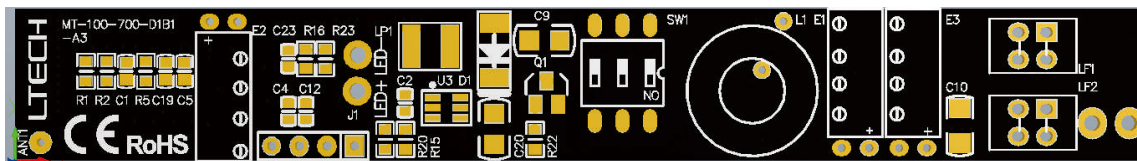

主视图

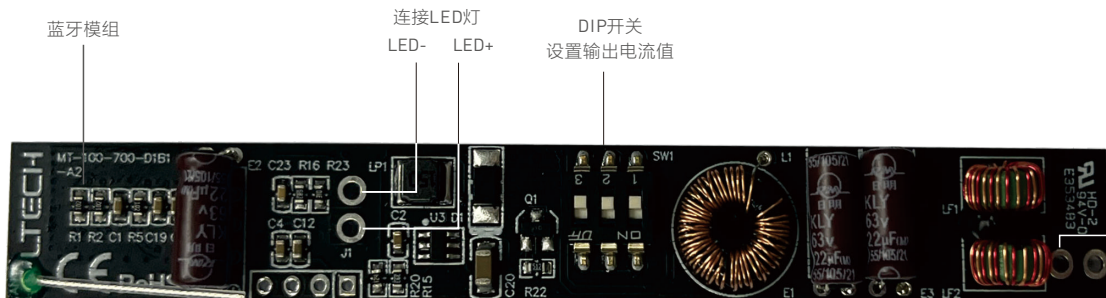

侧视图



V1
V2
输入电压
(不分正负极)

连线示意图

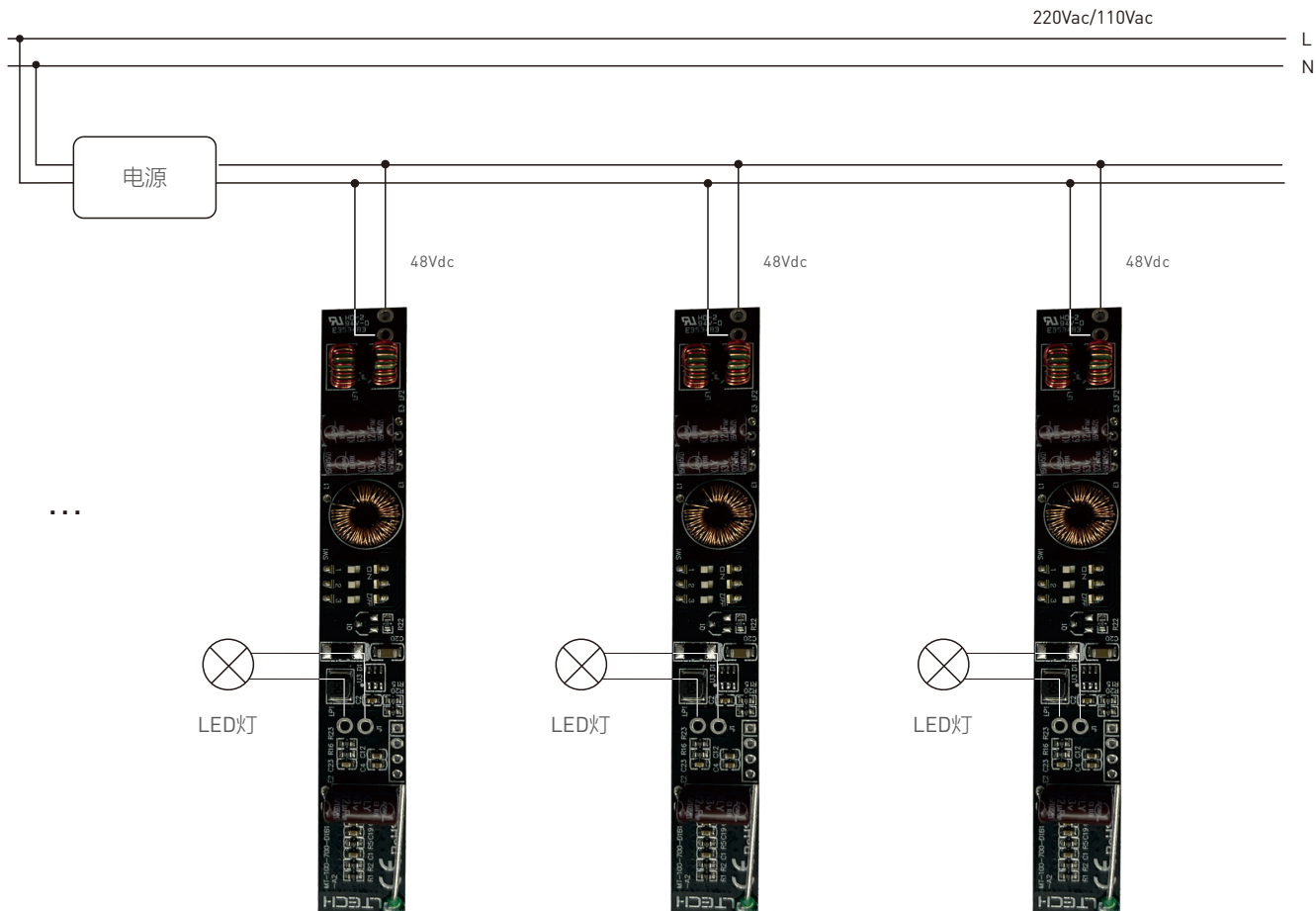

APP操作说明

1. 账号注册

通过手机扫描下方二维码，按提示完成APP安装后即可进行登录/注册操作。



扫码下载APP



2. 配对操作

新用户创建家庭后，点击右上角“+”进入添加设备列表，先将驱动器按照提示添加完成后，在添加设备列表选择“智能照明-调光（蓝牙）”后，按照界面提示，先将设备接通电源，确保设备处于未入网状态，然后点击“蓝牙搜索”后，按照提示完成添加设备。



3. 控制界面设置

配对完成后，进入控制界面，可以通过调节亮度达到想要的灯光效果。点击主题，进入主题界面，可一键切换多种主题灯光效果。点击模式，具有可编辑的高级模式。自定义动态模式，让您的生活更加丰富多彩。

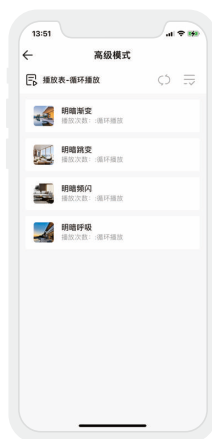
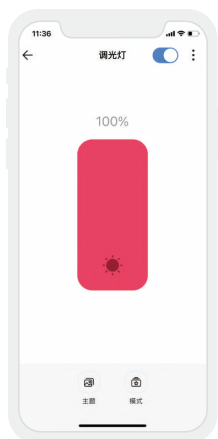

4. 灯具群组

同类型的灯具可以组成群组，用户可以对群组控制，操作更加便利。在“房间”界面，点击右上角“+”进入添加设备列表，选择对应的群组，如“调光灯组”，勾选要组成群组的设备即可。

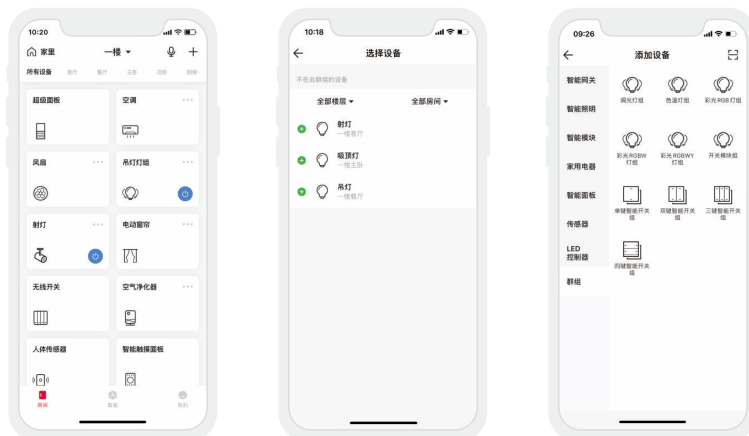

5. 高级功能

本产品可以通过与具有网关功能的设备联动（如超级面板），可实现云场景、自动化等高级功能。

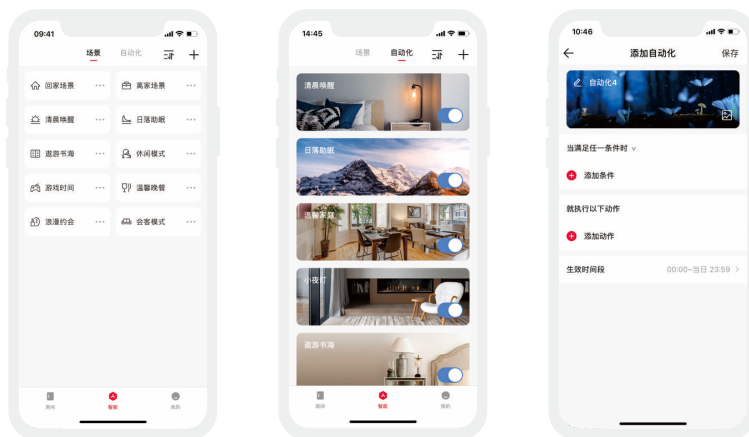

重置设备（恢复出厂设置）

确保驱动已接灯具且处于常亮状态下，使用开关让驱动连续断电6次（每次断电时间5秒，通电2秒），第六次通电2秒后，灯具闪烁5次，即表示驱动已恢复到出厂设置状态。



包装规格

型号	MT-100-400-D1B1、MT-350-700-D1B1
包装箱尺寸	37×29×19mm (L×W×H)
数量	240 PCS/箱
重量	0.015 kg/PC; 4.4 kg/箱

包装样式图



整箱包装

运输和贮存

1. 运输

产品适用车、船、飞机交通运输工具运输。

在运输中，应使用遮蓬进行防雨和防晒，并保持文明装卸，不应有剧烈振动、撞击等。

2. 贮存

贮存符合I类环境的规定。贮存期限超过6个月的产品建议重新检验，合格后方可使用。

常见问题

1. 设备添加失败怎么办？

- 1.1 确保设备正常通电，并且处于激活状态；
- 1.2 需要添加的设备未被其他账号添加过，如被添加过，请手动恢复出厂；
- 1.3 确保手机与设备两者尽量靠近，建议不超过20米；
- 1.4 如设备已被强制删除，请手动恢复出厂，然后重新添加设备。

2. 设备离线怎么办？

- 2.1 请检查设备是否正常通电；
- 2.2 请检查路由器是否工作正常，网络畅通；
- 2.3 如使用远程控制，请检查手机网络是否工作正常，网络畅通。

3. 如何远程控制/云场景设置？

如需远程控制/添加云场景设置，需搭配本司超级面板方可使用。

4. 如何共享设备？

请在“我的”-“家庭管理”，进入需要共享的家庭，点击“添加成员”，请按提示将需要设备共享的家人/朋友加入该家庭即完成共享。

注意事项

- 本产品请由具有专业资格的人员进行调试安装；
- 本产品(专有型号除外)不能防水，需避免日晒雨淋。如安装在户外，请使用防水箱；
- 良好的散热条件会延长产品的使用寿命，请把产品安装在通风良好的环境；
- 避免安装在雷区、强磁场和高压区域；
- 请检查使用的工作电压是否符合产品的参数要求；
- 通电调试前，确保所有接线正确且牢固，以免短路损坏部件，触发事故；
- 如果发生故障，请勿私自维修；如有疑问，请联系供应商。

* 本说明书的内容如有变更，恕不另行通知。若内容与您使用的功能有所不同，则以实物为准。如有疑问，请与供应商联系。

保修条例

- 自出厂之日起保修服务期为5年。
- 在保修服务期内出现产品质量问题雷特将给予免费修理或更换服务。

非保修条例：

属下列情况不在免费保修或更换服务范围之内：

- 已经超出保修服务期；
- 过高电压、超负载、操作不当等人为造成的损坏；
- 产品外形严重损坏或变形；
- 自然灾害以及人力不可抗拒原因造成的损坏；
- 产品保修标签和产品唯一条形码损坏；
- 无雷特签订的合同或发票凭证。

1. 修理或更换是雷特对客户唯一补救措施。雷特不承担任何附带引起的损害赔偿，除非在适用法律范围之内。

2. 雷特享有修正或调整本保修条款的权利，并以书面形式发布为准。

更新日志

版本	更改日期	更改内容	更改人
A0	2021.09.28	正稿	许淑钧
A1	2022.01.21	P1处添加工作电压范围	许淑钧
A2	2022.06.01	P1处添加tc点	许淑钧
A3	2022.08.30	更新所有产品图；将P1效率 (Typ) 更改为94%。	杨魏玲
A4	2023.09.14	更新所有产品图；PBC板、尺寸、接线。	杨魏玲